



P515-800

# B-Series, D-Series



Interchangeable Cylinder Assembly Instructions  
Instrucciones de ensambla de cilindros intercambiables  
Notice d'assemblée d'cylindres interchangeables

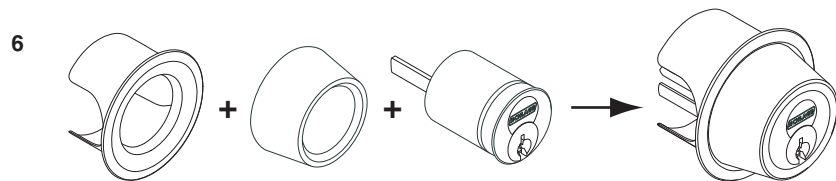
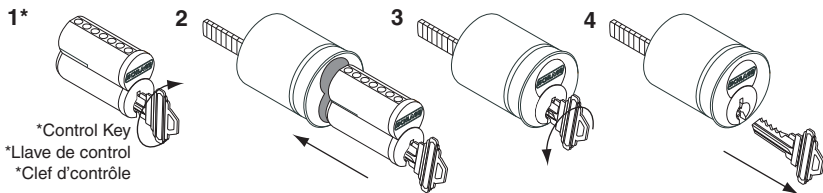
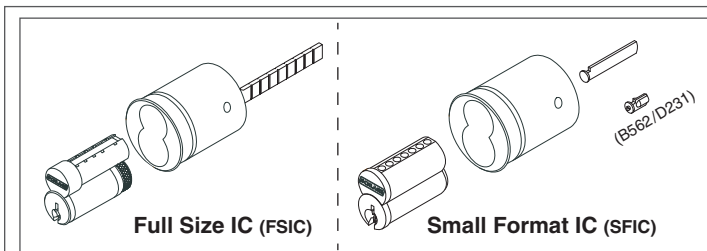

**5**  
(B562/D231 SFIC see reverse/vea el revés/voir l'inverse)  
(FSIC see reverse/vea el revés/voir l'inverse)

**SFIC Only:** Insert Driver Bar & Turn It Towards  
Extended Deadbolt in Door Edge

**SFIC Solamente:** Inserte la barra de impulsora  
y la vuelta hacia el cerrojo  
extendido en borde de la puerta

**SFIC Seulement:** Insérer la barre de transmission  
et le tourner vers le pêne dormant  
prolongé en bord de porte

Return to Lock Installation  
Vuelva al instalación de la cerradura  
Revenir à l'installation de serrure

**Customer Service**  
1-877-671-7011  
[www.allegion.com/us](http://www.allegion.com/us)

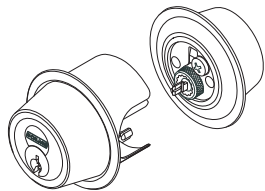

**B562/D231**  
**Double SFIC Cylinder Only**  
**Cilindros SFIC Doble Solamente**  
**Double Cylindre de SFIC Seulement**

**NOTE:** Driver bars must overlap inside deadbolt  
**NOTA:** Las barras deben traslapar adentro el cerrojo  
**NOTE:** Les barres doivent recouvrir à l'intérieur de le pêne dormant

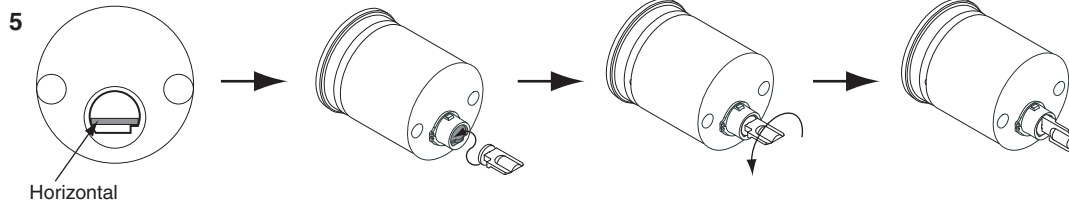
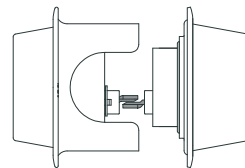

Return to Front  
 Vuelva al frente  
 Revenir à l'avant

**Double FSIC Cylinder Only**  
**Cilindros SFIC Doble Solamente**  
**Double Cylindre de SFIC Seulement**

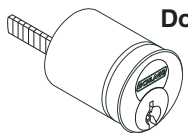

**5 Determine Driver Bar Length**  
**Determine el tamaño de la barra impulsora**  
**Determiner la longueur de la barre de transmission**

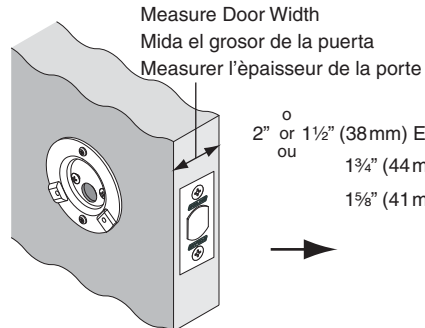

EXT = Optional Extender Rings  
 Anillos extensibles opcionales  
 Anneaux de prolongation facultatifs

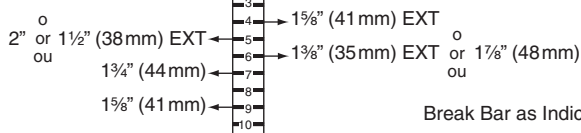

Break Bar as Indicated  
 Rompa la barra según lo indicado  
 Casser la barre comme indiqué

