



653071

# 650 Series Keyswitches



Installation Instructions and Template

① 653 Models mount in a standard single-gang box as shown below. Template may be cut out or follow dimensions for prep of mounting area. See other side for special application notes.

## Template



**DO NOT PHOTOCOPY THIS DOCUMENT!  
TEMPLATE MUST BE TO SCALE.**

Standard Keyswitch  
5A @ 30VAC/VDC

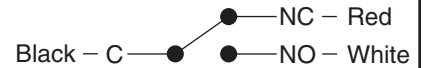

ATS switch closes  
when cover is on.  
0.500A @ 30VDC



LED indicator lights  
operate @ 12-24VDC  
0.025A @ 28VDC

Red (+)  
Black (-)

Recommended cutout for 653 Keyswitches.

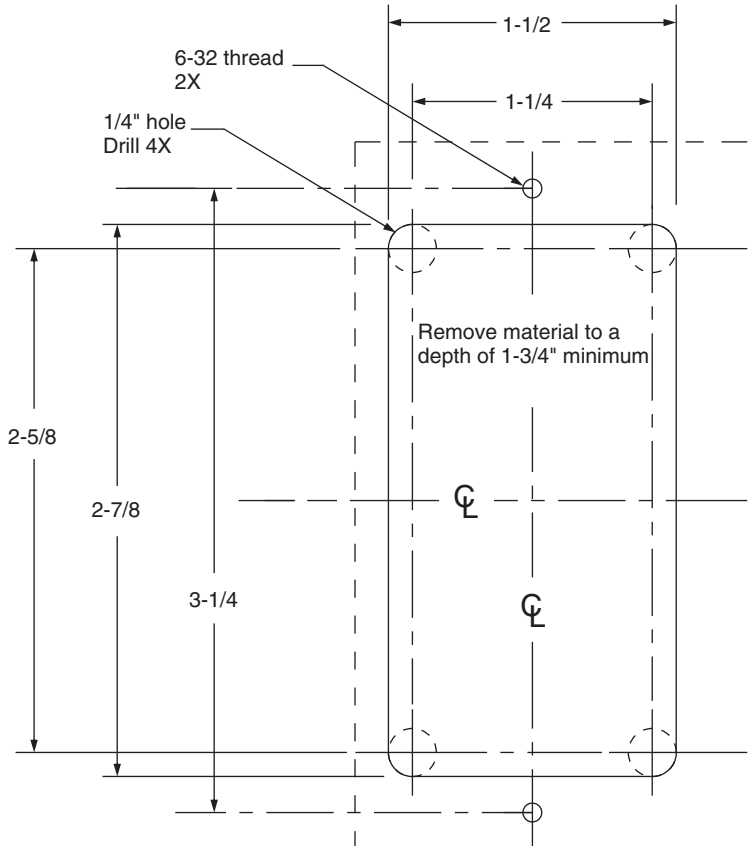

Blocking Ring required for cylinders over 1-1/8"  
Thickness = cylinder length - 1-1/8"

Anti-Pullout Tab (optional)

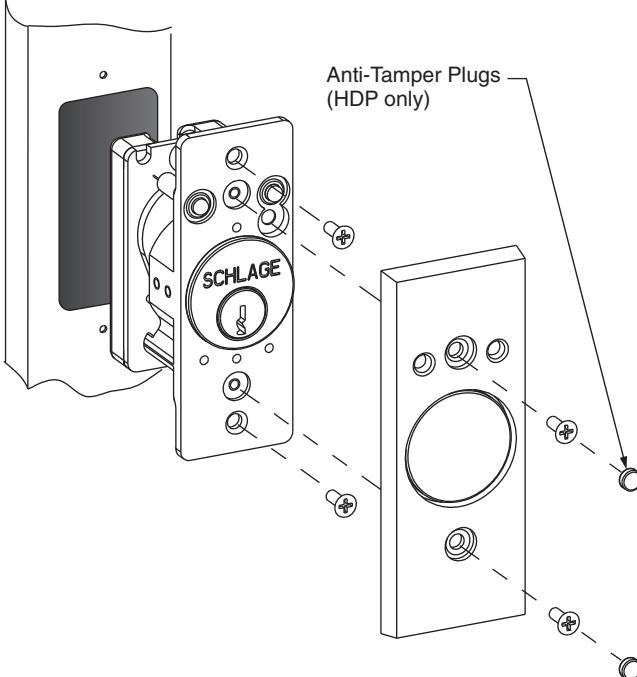
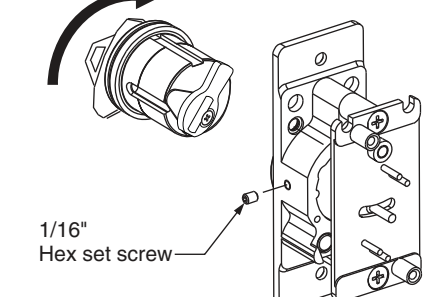
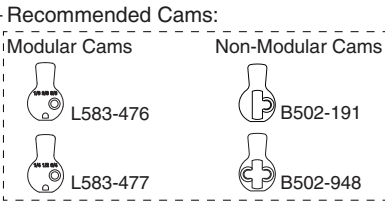









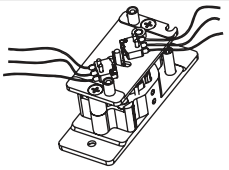
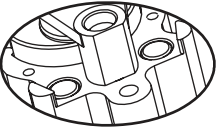

## Functions

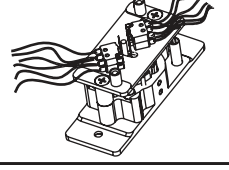
The 653 Keyswitch comes with all parts (except switch assemblies) to make any function shown below. If switch assemblies are needed, order P/N P653059.

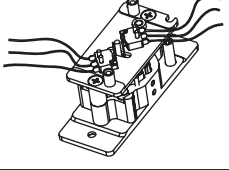
**NOTE:** The Keyswitch uses magnetic springs to activate. Dot facing up on Spring Magnet configures momentary action; dot down configures maintained action. For maintained key, remove one position (041 and 141 functions). Stop pins will be needed.

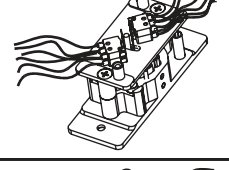

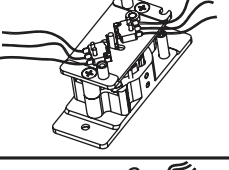
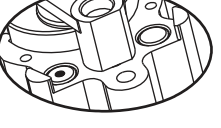

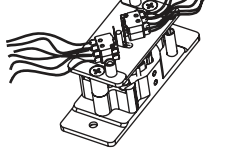
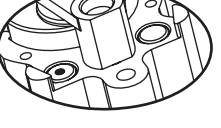

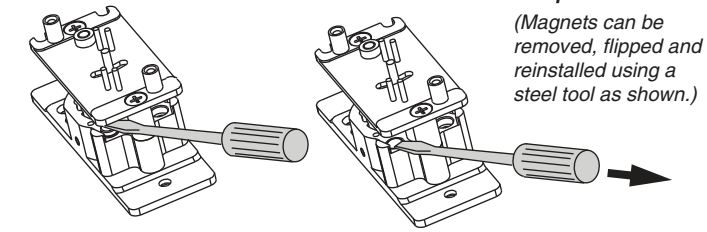
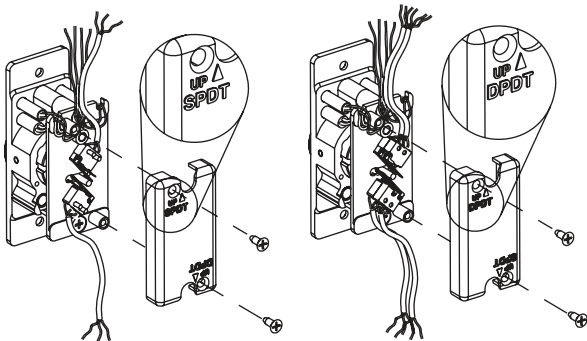

**Stop Pins**      **Stop Magnet**      **Spring Magnet**  

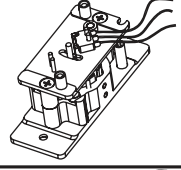
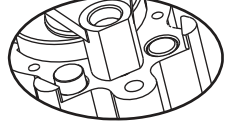

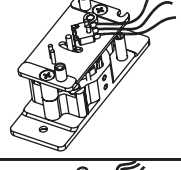
**Dot Up**      **Dot Down**  
*(Magnets can be removed, flipped and reinstalled using a steel tool as shown.)*

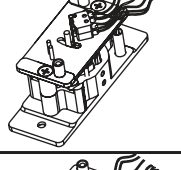

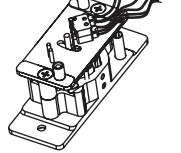
Function	Switch Configuration	Magnet Configuration
 653-0404 CCW-SPDT-CW Maintained Maintained		
 653-1414 CCW-DPDT-CW Maintained Maintained		
 653-0505 CCW-SPDT-CW Momentary Momentary		
 653-1515 CCW-DPDT-CW Momentary Momentary		
 653-0405 CCW-SPDT-CW Momentary Momentary		
 653-1415 CCW-DPDT-CW Momentary Momentary		

Verify switch cover is oriented correctly for switch configuration. Note that only one, two or four switches can be installed. Three is not recommended.

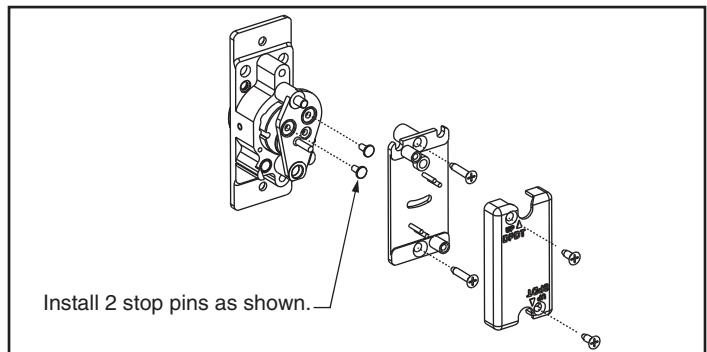

Function	Switch Configuration	Magnet Configuration
 653-04 SPDT-CW Maintained		
 653-05 SPDT-CW Momentary		
 653-14 DPDT-CW Maintained		
 653-15 DPDT-CW Momentary		

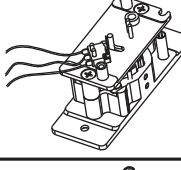
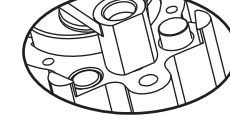

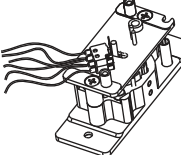
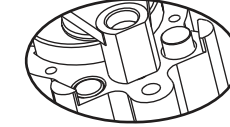
 653-041 CCW-SPDT Maintained Key can not be removed when switch is activated.		
 653-141 CCW-DPDT Maintained Key can not be removed when switch is activated.		

**Customer Service**

1-877-671-7011      www.allegion.com/us