

Schlage Control™ Smart Deadbolt

with ENGAGE Technology



Model BE467F

Door Preparation Instructions for Door with Existing Holes

Tools Needed

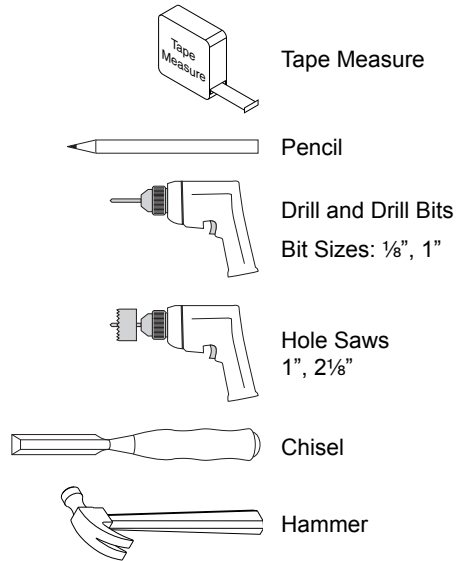

1 Measure door thickness.

If the door is thinner than $1\frac{3}{8}$ " or thicker than $1\frac{3}{4}$ ", then the lock will not fit properly on the door.

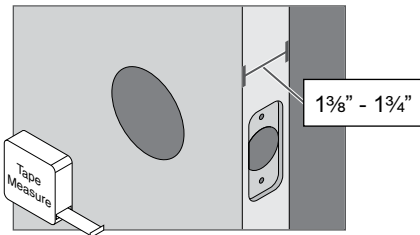

① **A thick door kit is available from Product Support at 800-847-1864.**

2 Measure the backset.

If existing backset is not $2\frac{3}{4}$ " or $2\frac{3}{8}$ ", then the lock will not fit properly on the door.

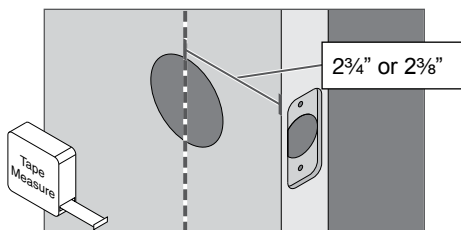

3 Measure the hole sizes.

3a If hole sizes are larger than those shown, then the lock will not fit properly on the door. If hole sizes are smaller than those shown, see steps **3b** and **3c**.

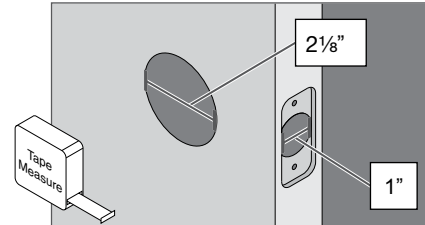

3b If necessary, enlarge hole in door face.

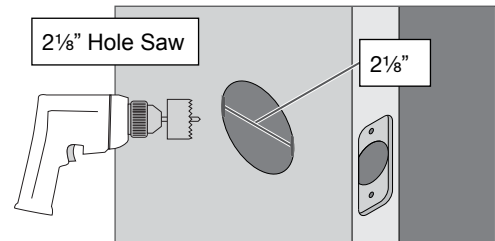

3c If necessary, enlarge hole in door edge.

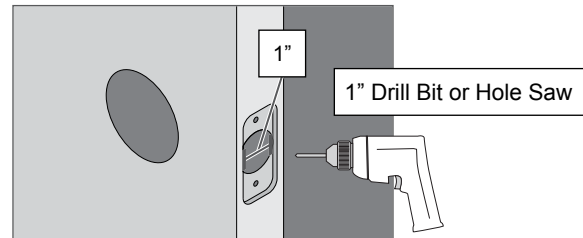

4 Check the door jamb.

- 4a Place new strike and reinforcement plate against the door jamb. If these do not fit properly, see steps **4b** and **4c**.

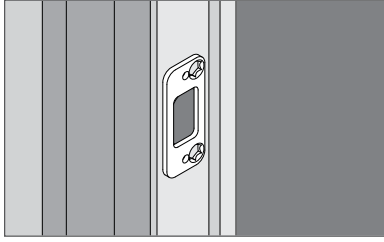

- 4b If correction is necessary, trace faceplate and mark holes.

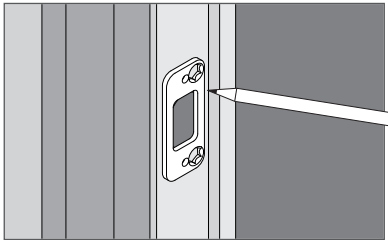

- 4c If necessary, use chisel, hammer and drill to correct door jamb preparation.

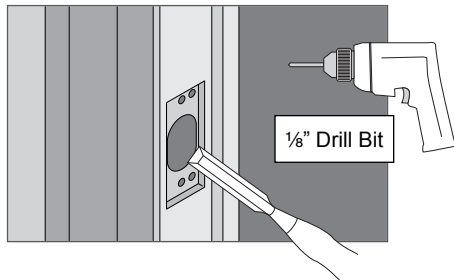

Product Support

800-847-1864

www.allegion.com

